



Morex Design
Diseño metálico
aplicado a la
envolvente

En Morex Design, nuestras celosías metálicas integran diseño, funcionalidad y precisión constructiva, aportando sombra, privacidad y control visual a distintos espacios arquitectónicos.

Su composición permite regular la luz, favorecer la ventilación y enriquecer la expresión material del proyecto, transformándose en un elemento clave para fachadas, cerramientos y envolventes contemporáneas.

Celosías metálicas para envolventes arquitectónicas

(pueden ser mecanizadas o soldadas)

Diseño Lama

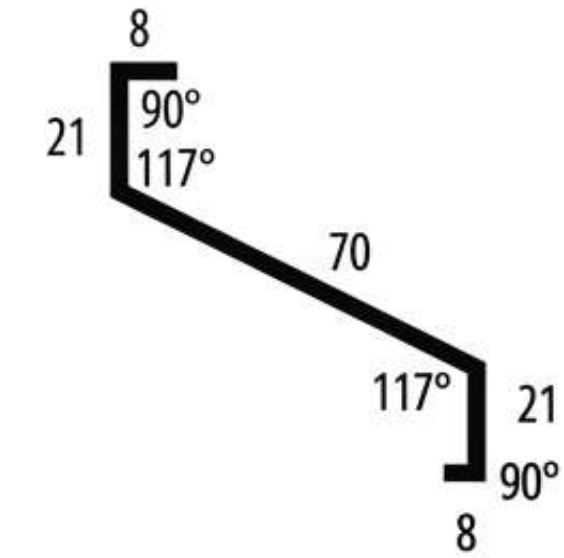
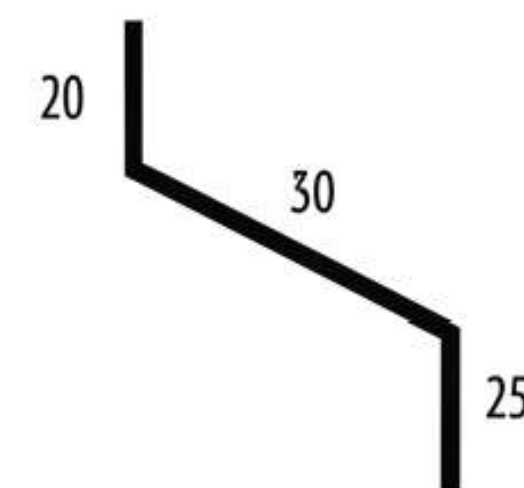
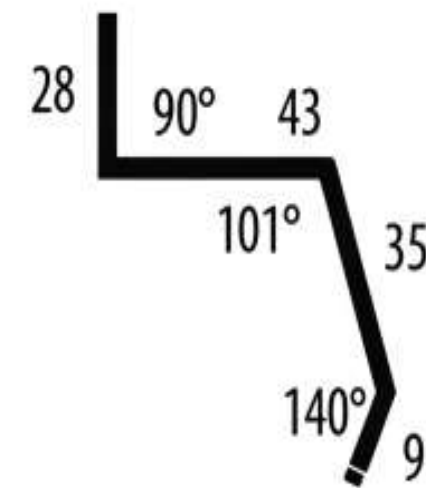
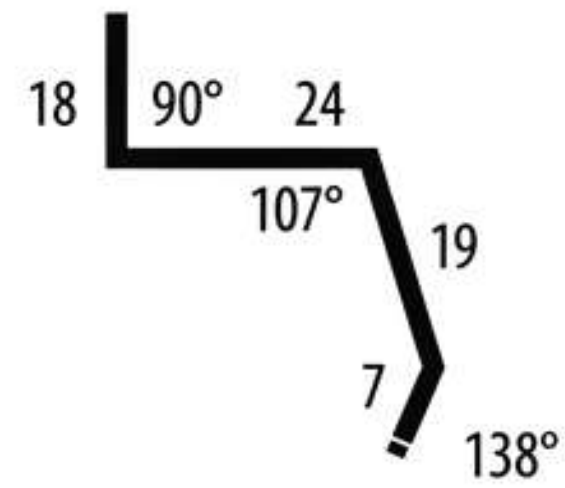

Axonométrica



Paño armado



Celosías metálicas para envolventes arquitectónicas

(pueden ser mecanizadas o soldadas)

Diseño Lama

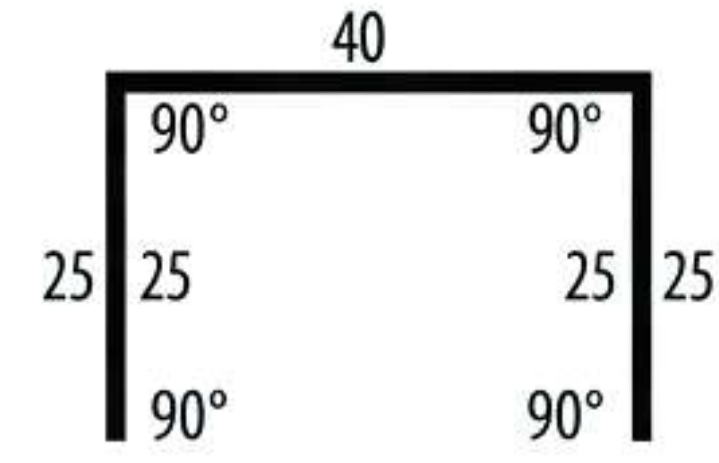
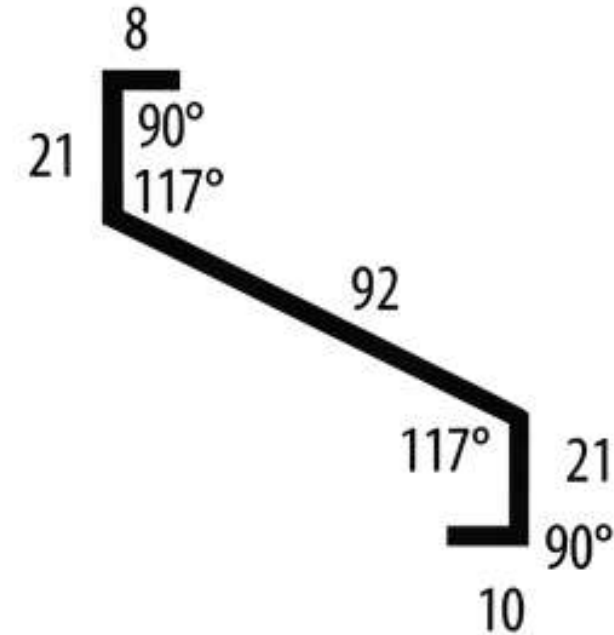
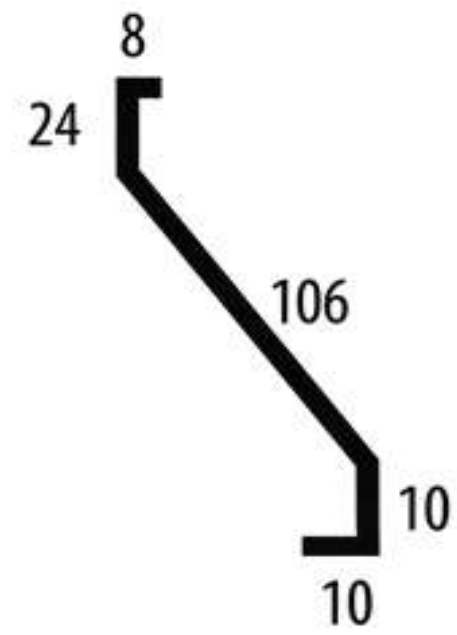

Axonométrica

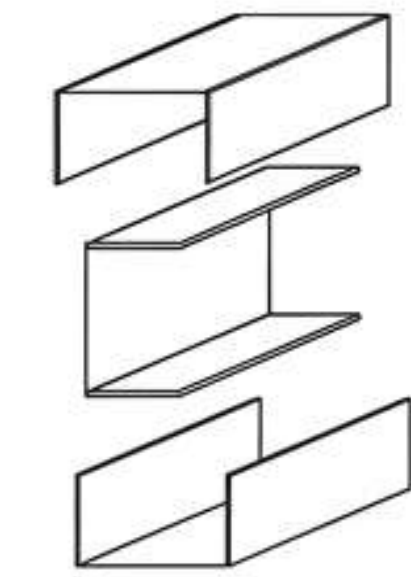

Paño armado

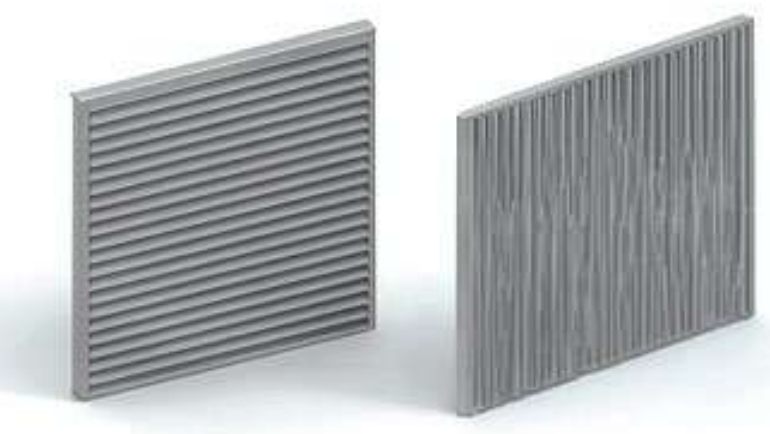
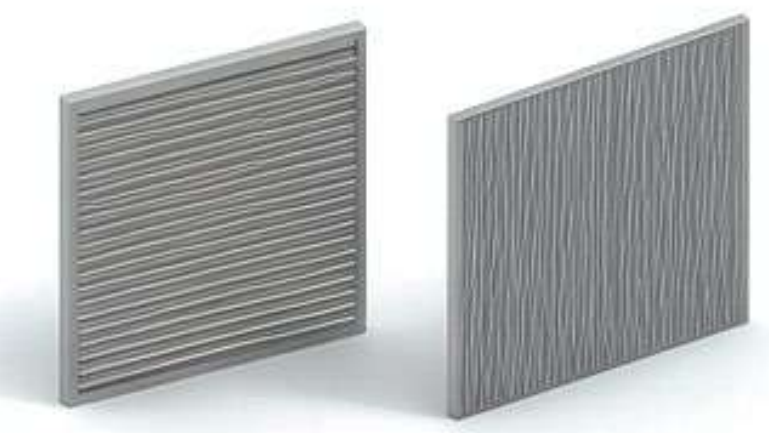

Celosías metálicas para envolventes arquitectónicas

(pueden ser mecanizadas o soldadas)

Diseño Lama

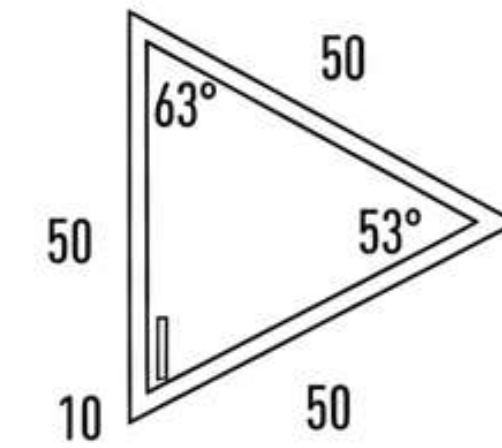
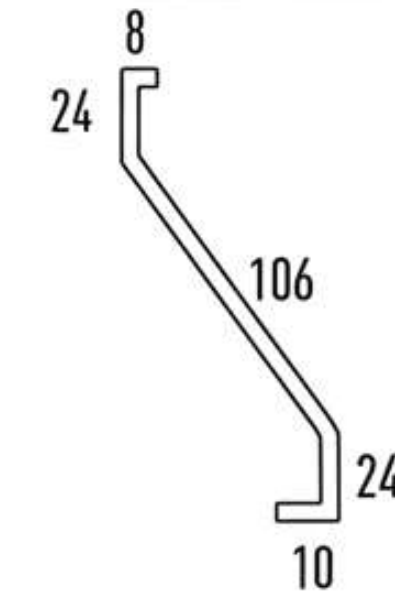
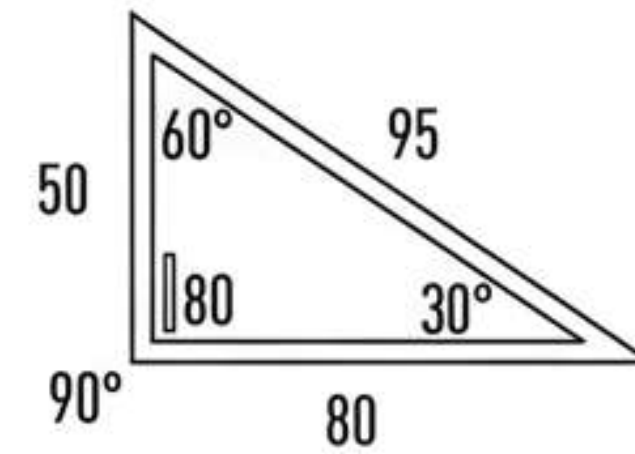
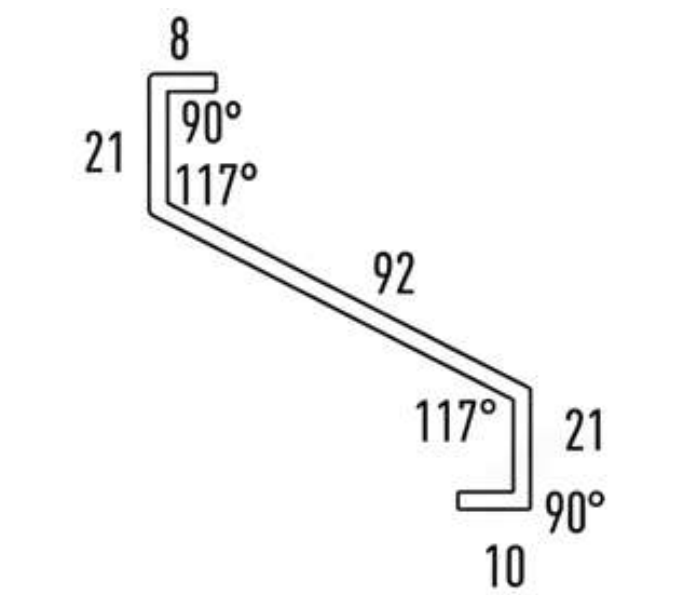

Axonométrica



Paño armado



Morex Design integra diseño arquitectónico, desarrollo técnico y fabricación metálica para materializar soluciones a medida. Cada sistema se adapta a las condiciones del proyecto, considerando modulación, materialidad, terminación, montaje y desempeño constructivo.



www.morex.cl

 +562 2780 9090

 +569 8837 2791